

BV:

Name:

Ort:

Straße:

Telefon:

Fax:

Nr. 70 download

Gewünschter – Lift

Rollstuhlplattformlift:

Sitzlift:

bitte ankreuzen:

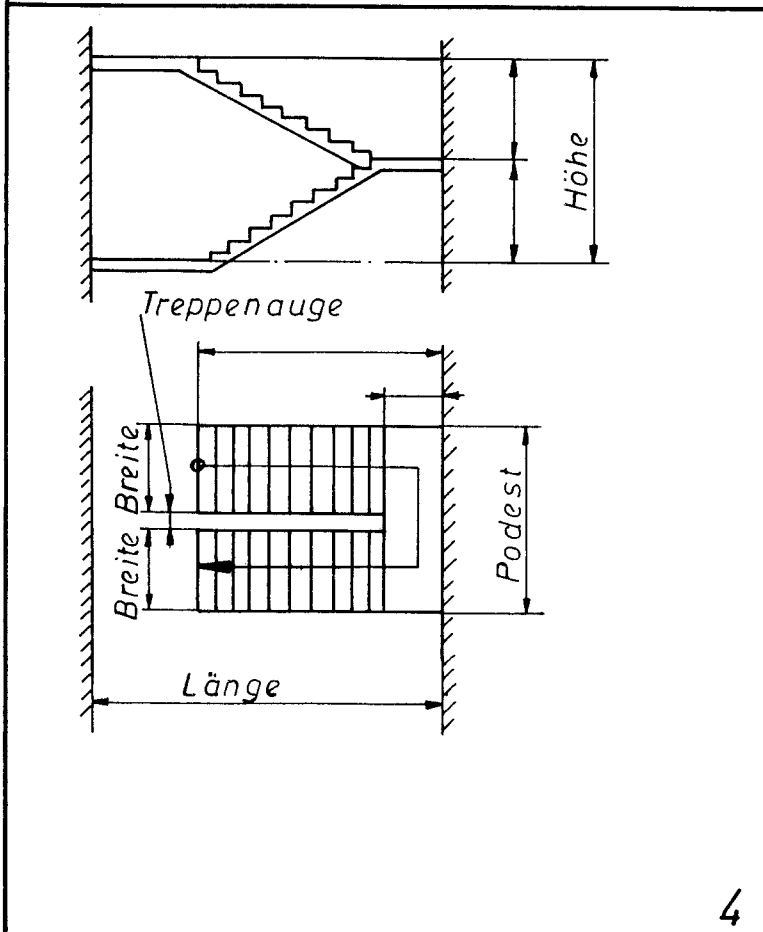
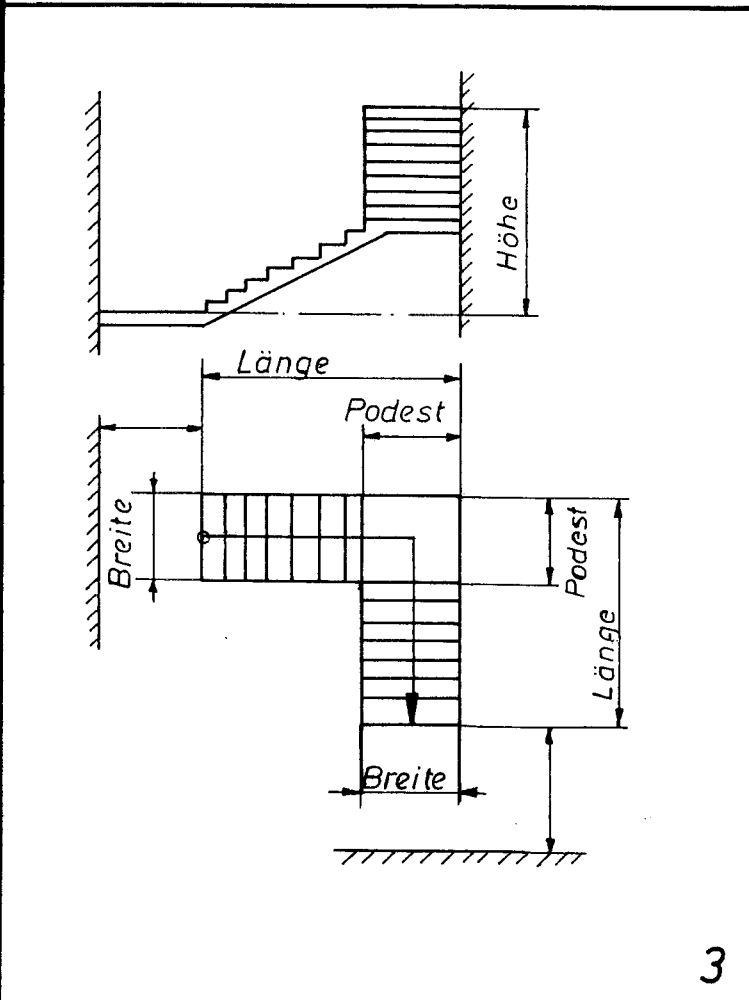
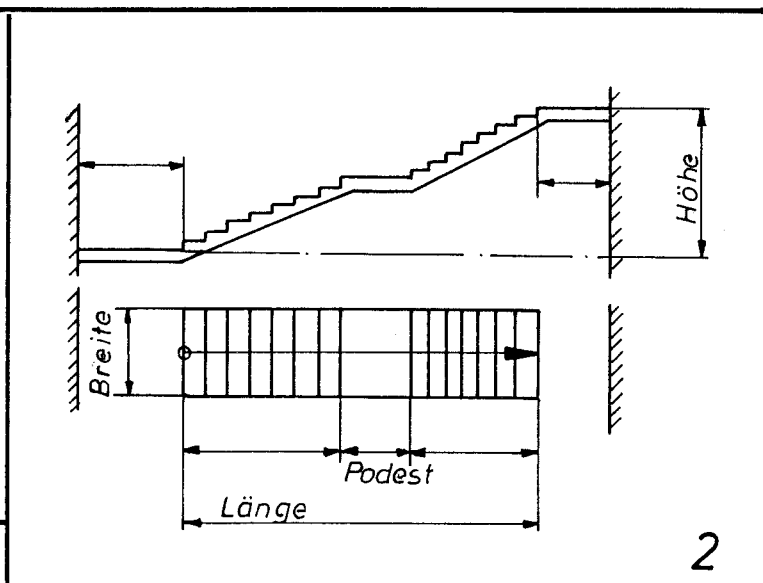
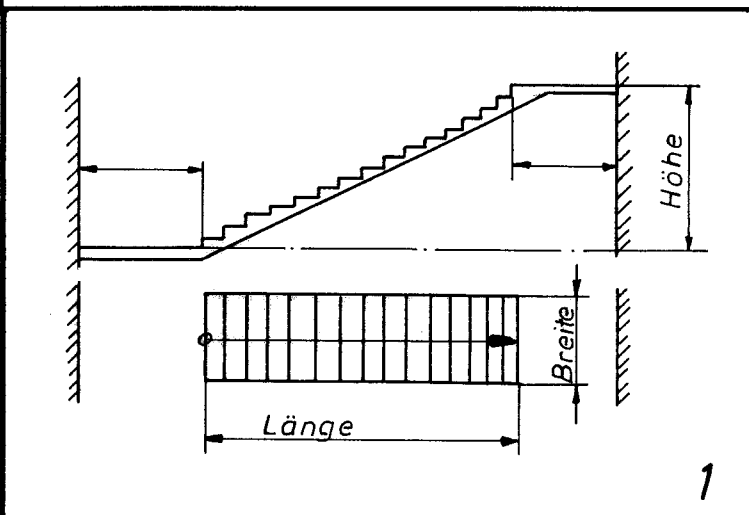

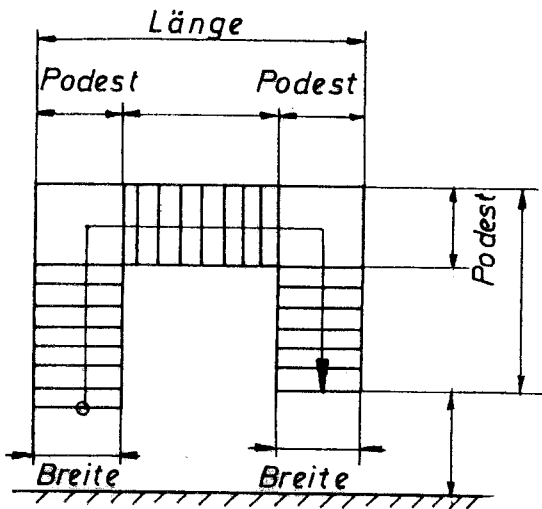
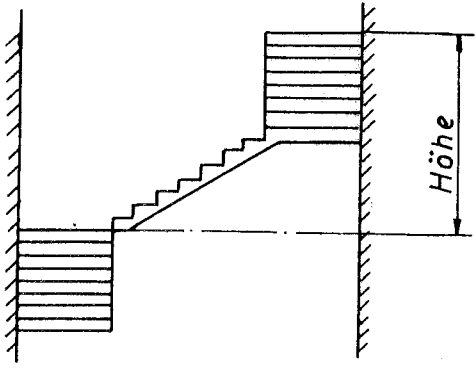

5

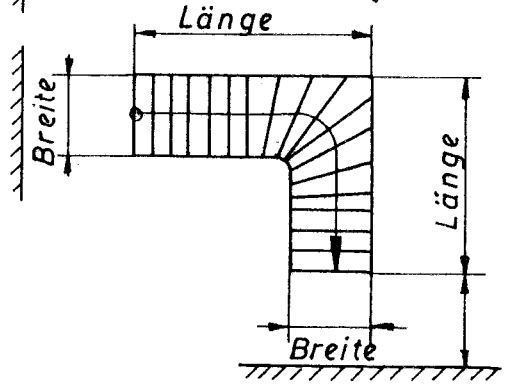
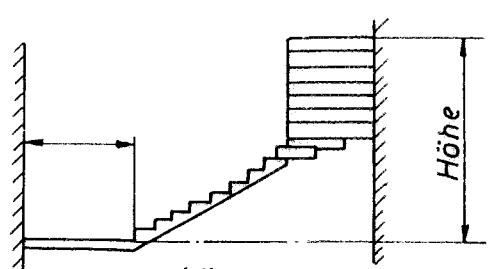

6

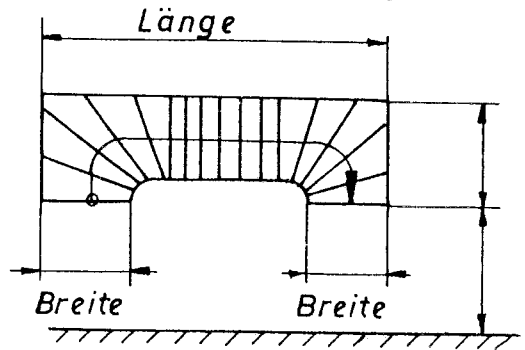
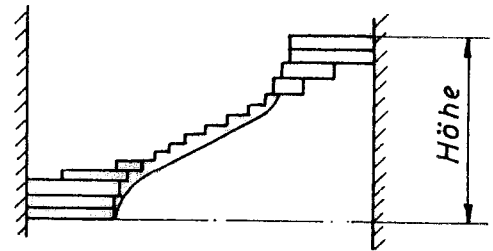

8

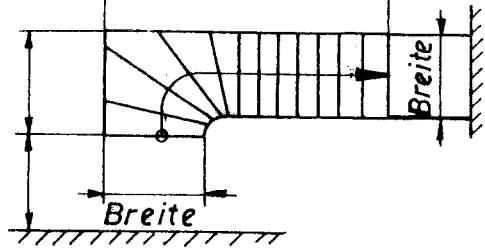
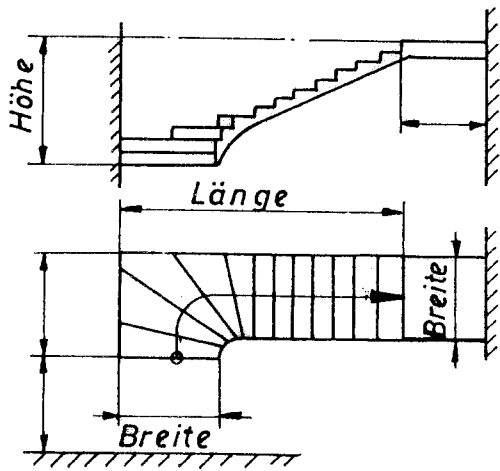

7

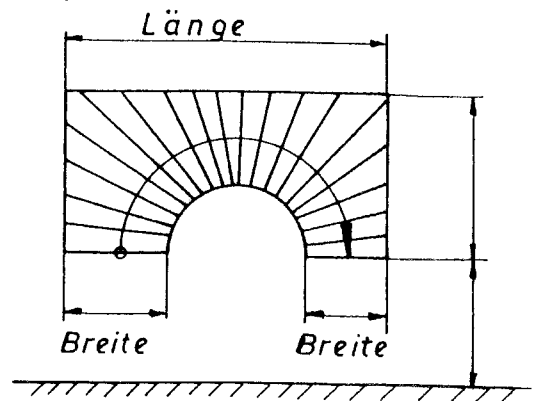
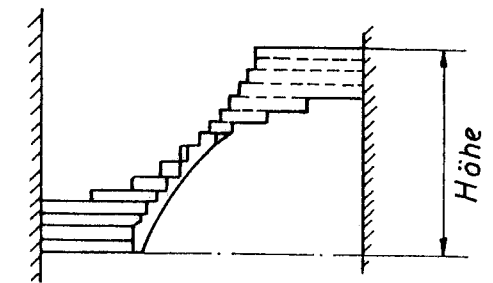

9 10

